

2.5 System-specific rules miniaturegolf

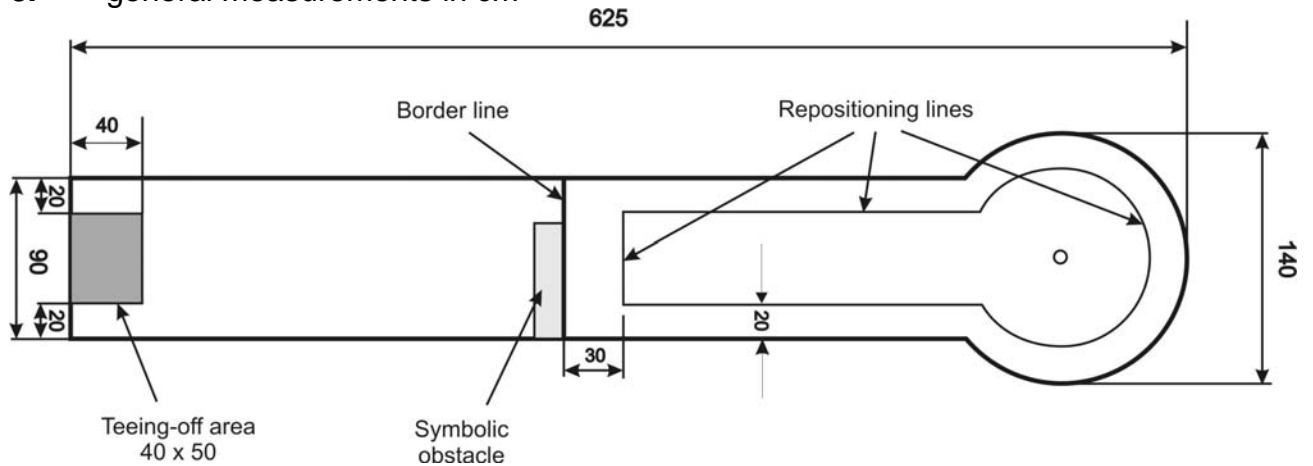

1. In general, miniaturegolf lanes have the following dimensions:
Length: 6,25 m Width: 0,90 m Target circle diameter: 1,40 m
2. The authoritative drawings for standardization are kept by the WMF.
3. Only courses with standard dimensions and with 18 of the 28 standardized lanes can be approved as miniaturegolf courses.
4. The lanes can be arranged in any order from 1 to 18
5. Mirror-image versions of lanes 1, 2, 3, 5, 10, 11, 12, 18 and 19 are permitted.
6. The following lanes and obstacles are standardized:
 1. pyramids
 2. loop
 3. sloped circle with kidney
 4. double waves
 5. flat loop
 6. bridge
 7. jump with net
 8. straight lane with target window
 9. pipe
 10. sticks
 11. labyrinth
 12. truncated cones
 13. double wedges
 14. passages
 15. middle hill
 16. volcano
 17. "V"-obstacle
 18. angle
 19. lightning
 20. straight lane without obstacles
 21. sloped circle without obstacles
 22. plateau
 23. wedge with target window
 24. sloped lane without obstacles
 25. sloped circle with "V"-obstacle
 26. straight lane with jump
 27. rhombus
 28. straight lane with target hill
7. In every target circle there must be a repositioning marking line at a constant distance of 20 cm from the boundary. Further repositioning markings are defined at each lane in the following.

8. general measurements in cm



9. It is not allowed to step inside the lanes (including obstacles) or to cross or jump over the lanes. It is allowed to step on the boundary when playing a stroke.

Lane 1 pyramids

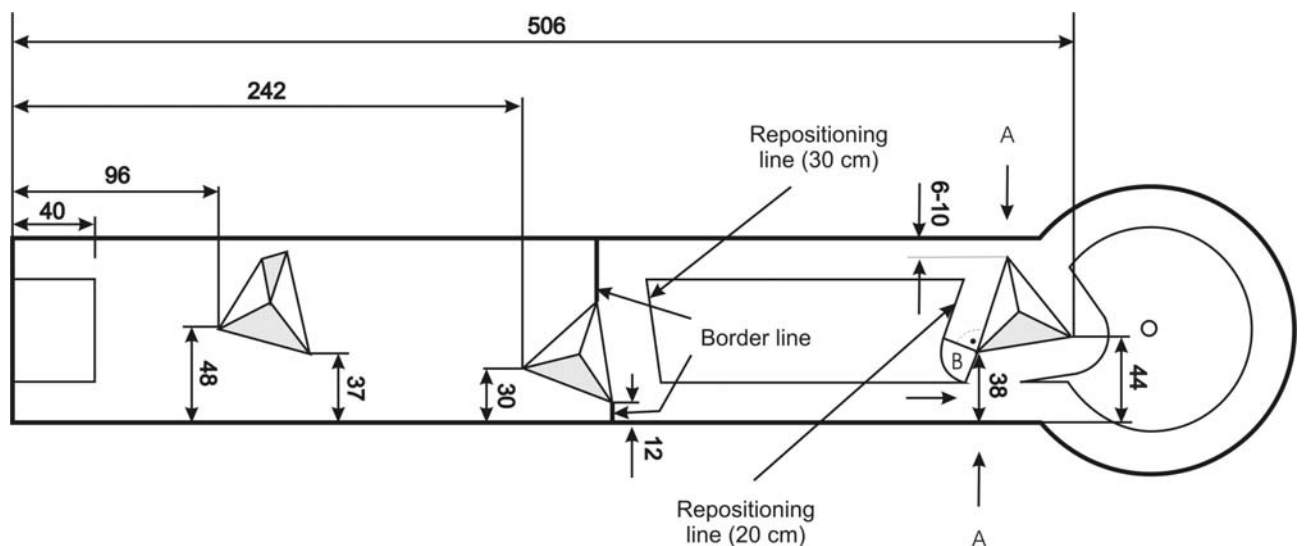

Intended path: Not laid down

Repositioning: If the ball comes to rest in sector B (see diagram) it can be repositioned at up to 20 cm radially from the pyramid. Should the space between the obstacle and the boundary be too small for the ball to be repositioned then the following regulations apply:

If the ball comes to rest in front or directly at of the narrowest part between the pyramid and the boundary (two markings A in diagram), it can be repositioned at up to 20 cm away from the boundary and the obstacle in the direction of the teeing-off area.

If the ball comes to rest behind the narrowest part, it can be repositioned at up to 20 cm away from the boundary and the obstacle in the direction of the target.

Measurements: See diagram

Lane 2 loop

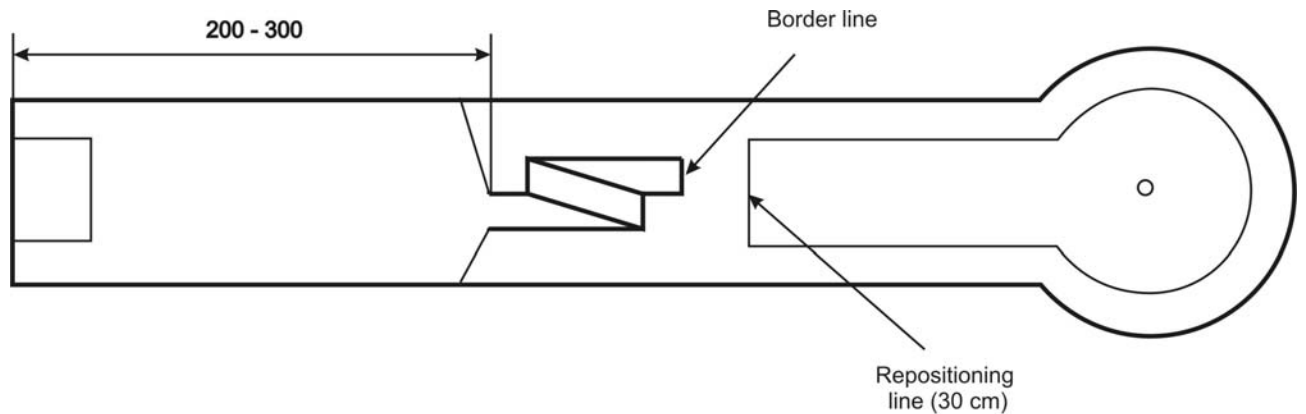

Intended path: Through the somersault

As the path of the ball is not always controllable in the somersault, the obstacle can be considered as completed if the ball correctly crosses the entrance and the exit. Even a ball which jumps from the entrance to the exit and thereby leaves out the actual somersault, is still acceptable if it leaves the exit correctly. However, should the ball jump over the outside walls of the obstacle, it has left the intended path.

Measurements: beginning of obstacle 200 – 300 cm from beginning of the lane
width of obstacle 15 – 22 cm

Lane 3 sloped circle with kidney

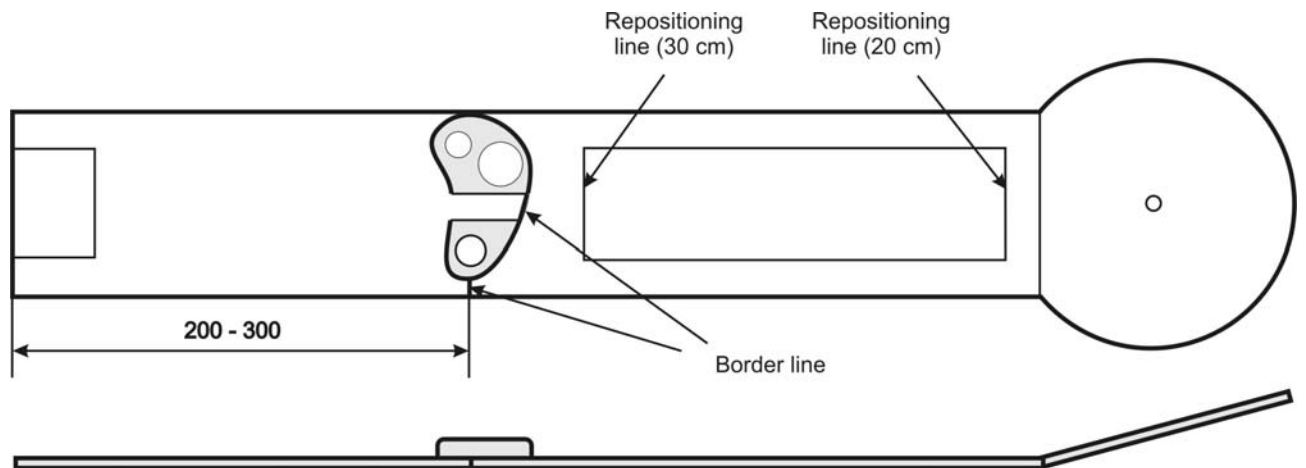

Intended path: Either through the tunnel as a straight stroke or passing the obstacle on the right side

Measurements: center of obstacle 200 – 300 cm from beginning of the lane
width of obstacle in the middle 15 – 22 cm
at boundary 8 – 13 cm

Lane-specific rule: If a ball passes the border line backwards it can be stopped while still in motion.

Lane 4 double waves

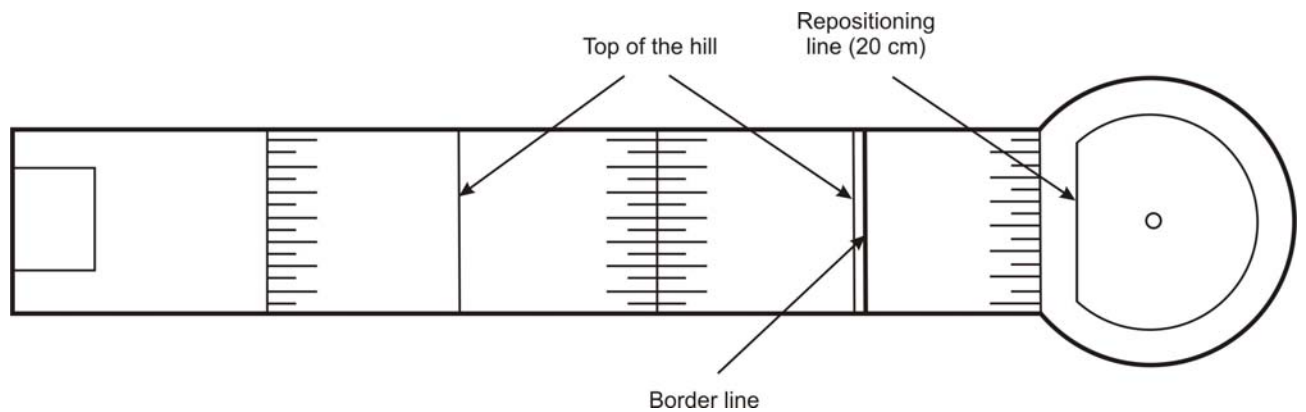

Intended path: Not laid down

Border line: Right after the top of the second hill

Lane 5 flat loop

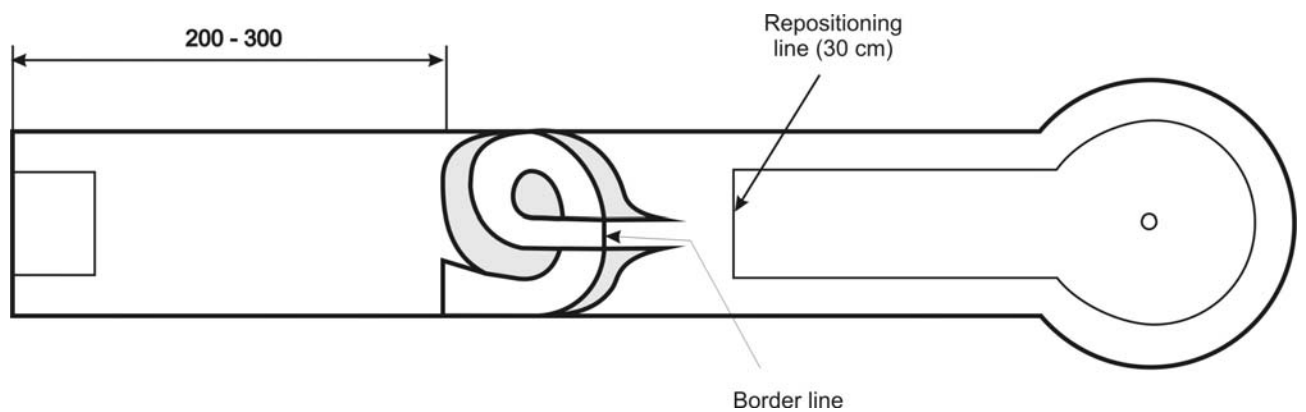

Intended path: The ball must go through the entrance and the complete length of the loop up until the border line. The ball leaves the intended path if it jumps over the raised sides before the border line, or if it leaves out the loop.

Measurements: beginning of obstacle 200 – 300 cm from beginning of the lane

Lane 6 bridge

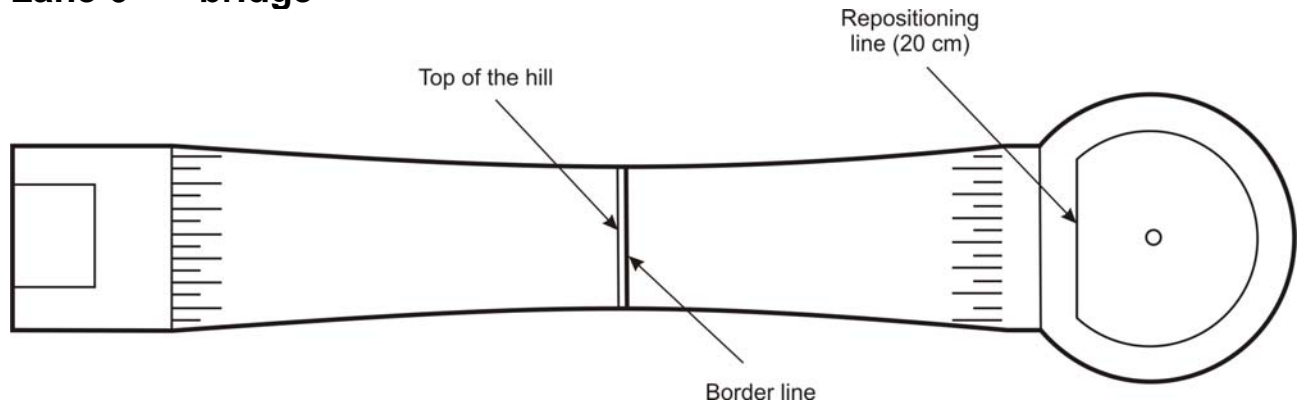

Intended path: Not laid down

Border line: Right after the top of the hill

Lane 7 jump with net

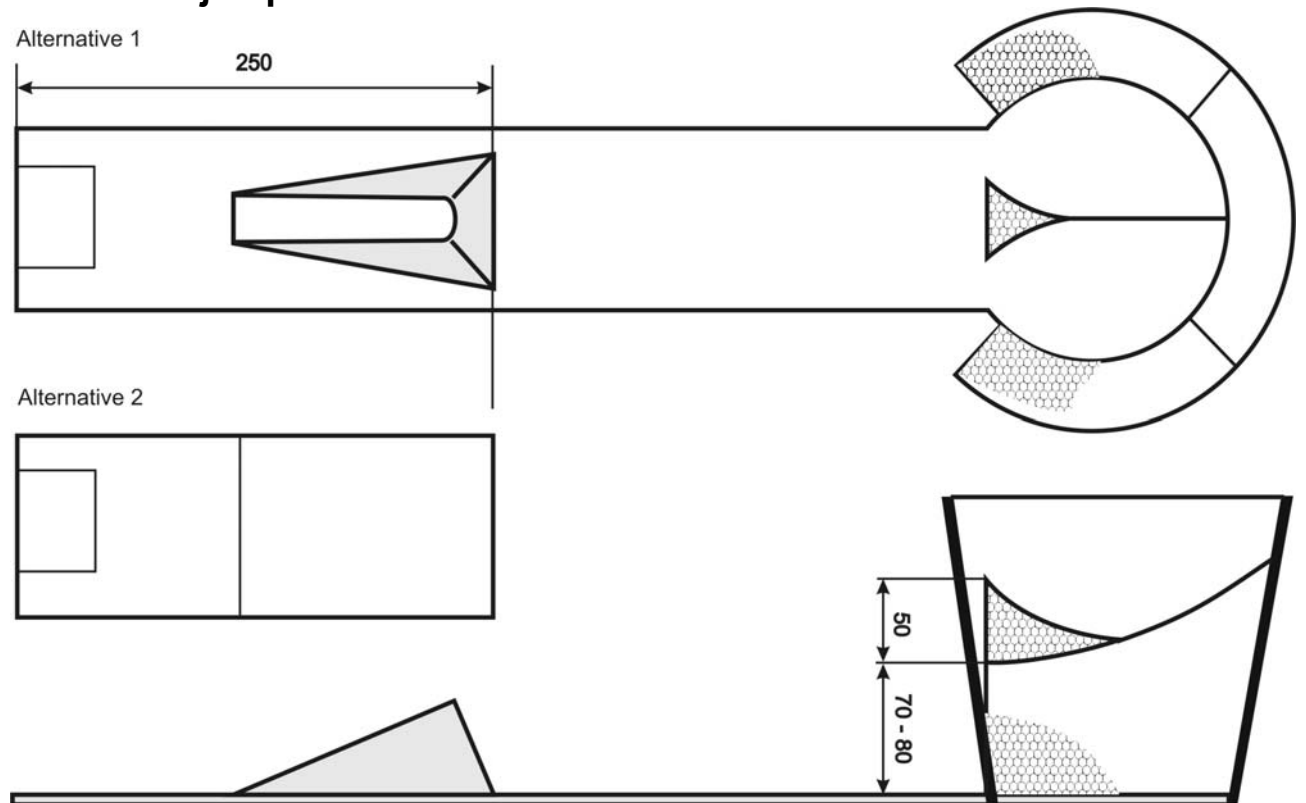

Intended path: The direct line of flight from the teeing-off area touching the ski-jump into the net

Measurements: Net ring 50 cm in diameter
 End of obstacle 250 cm from beginning of the lane
 distance between teeing-off level and lower edge of ring: 70 - 80 cm.

Border line: Lane without border line

Target: The inside of the net

Lane-specific rule: It is allowed to step inside the lane for retrieving the ball.

Lane 8 straight lane with target window

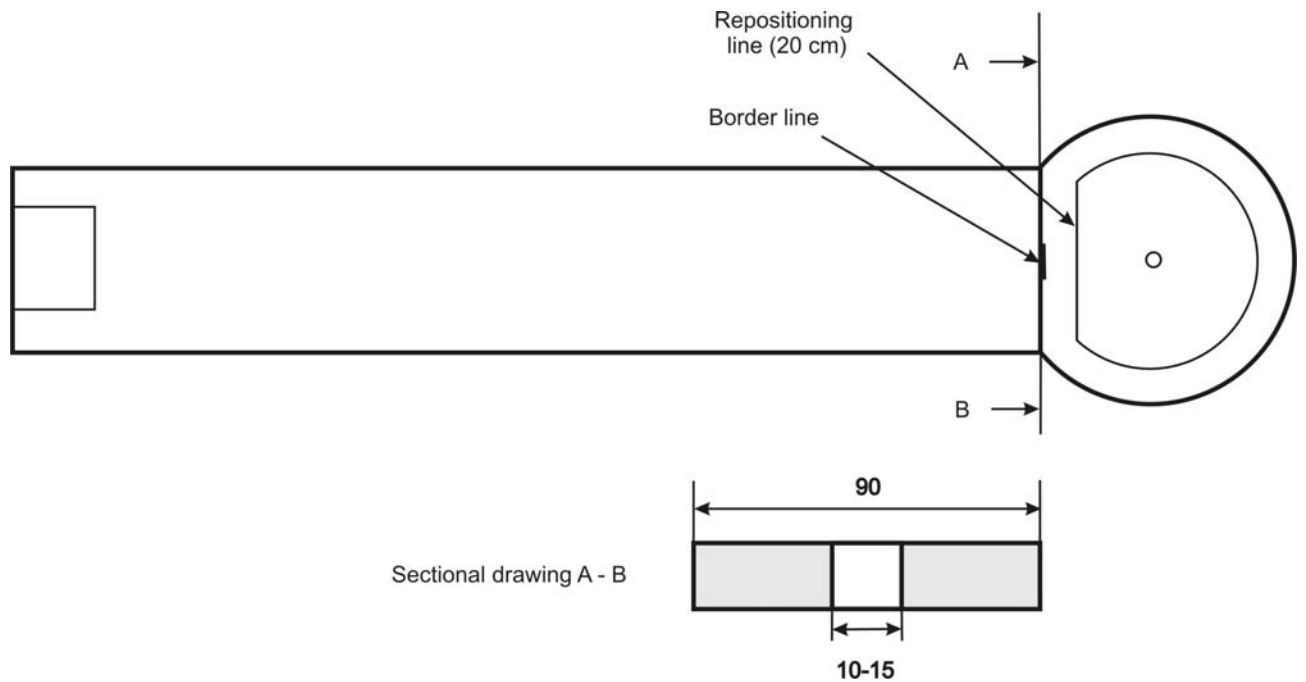

Intended path: Through the window

Measurements: Rear edge of obstacle 500 cm from the beginning of the lane
width of obstacle 10 – 15 cm

Lane 9 pipe

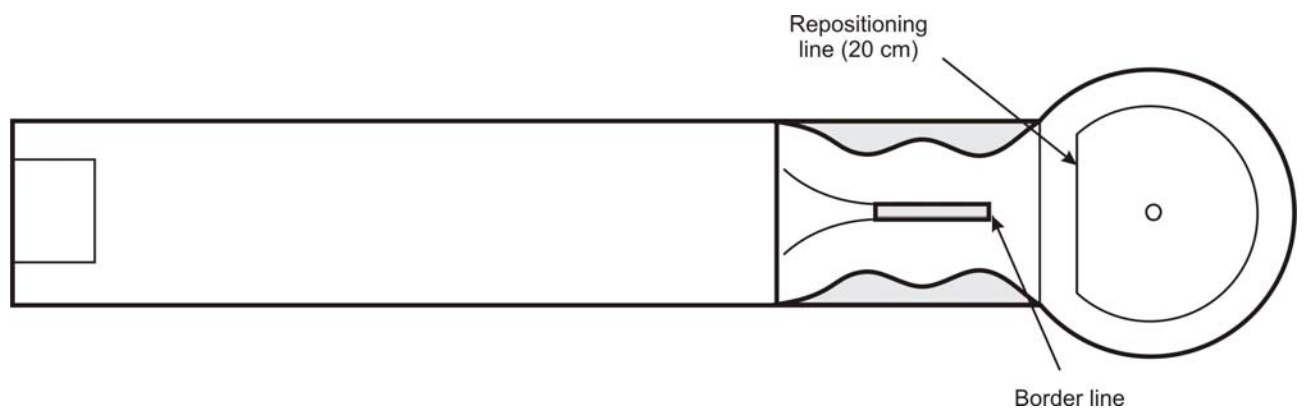

Intended path: Only through the pipe

Measurements: Rear edge of obstacle 500 cm from the beginning of the lane
diameter of the pipe 5 – 6,5 cm

Border line: Right at the exit of the pipe

Lane 10 sticks

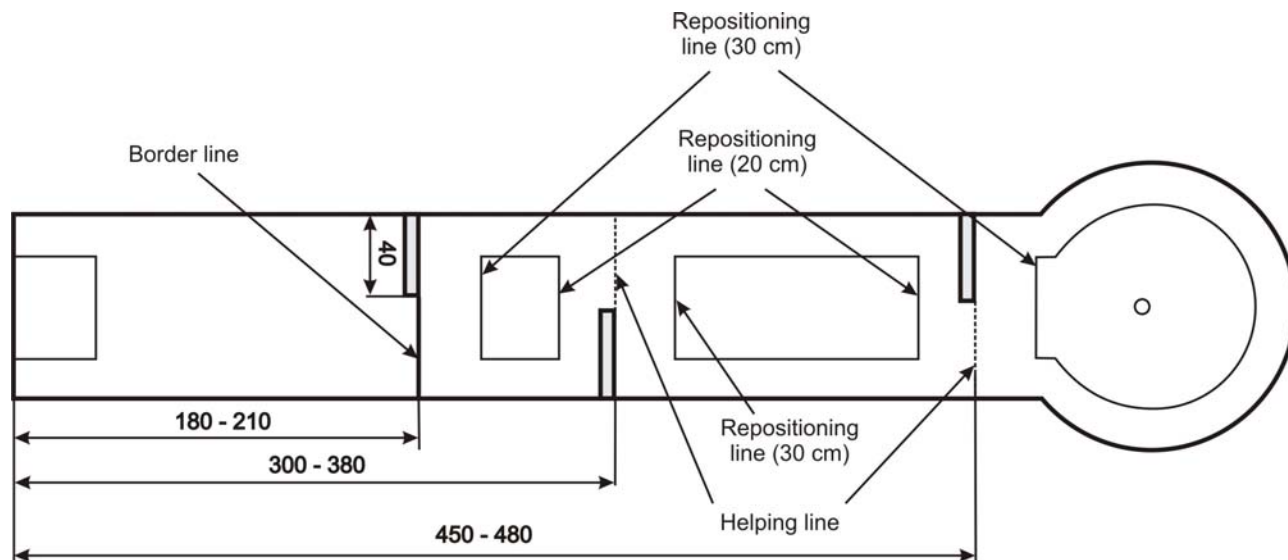

Intended path: Between the obstacles (not over them).

Measurements: see diagram

Helping line: A helping line is marked right at the end of the second and third obstacle.

Alternatives: Position of each stick can be on left or right side.
Third stick can be excluded.
On each side has to be at least one stick.

Repositioning: If the ball comes to rest close before or on the helping line with its point of contact, it can be repositioned at up to 20 cm from the obstacle in the direction of the teeing-off area. If it has passed the helping line, it can be repositioned at up to 30 cm from the obstacle in the direction of the target.

Lane 11 labyrinth



Intended path: Although the obstacle has four entrances, only the second entrance from the right-hand side leads to the target. The remaining entrances must be blocked in such a way as to prevent the ball from reaching the target.

Measurements: width of gate 12 - 20 cm

Border line: Lane without border line.

Target: The target area is defined by the area between the parallel vertical irons in the center of the labyrinth only (see diagram). It can be designed with or without target hole.

Lane 12 truncated cones

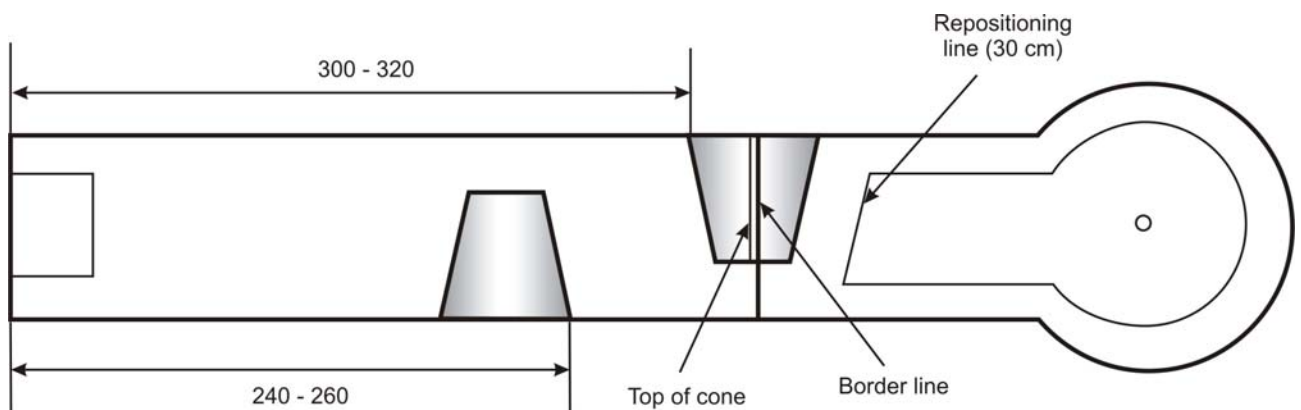

Intended path: Not laid down.

Measurements: see diagram

Border line: Right after the top of the second cone prolonged to the opposite frame

Lane 13 double wedges

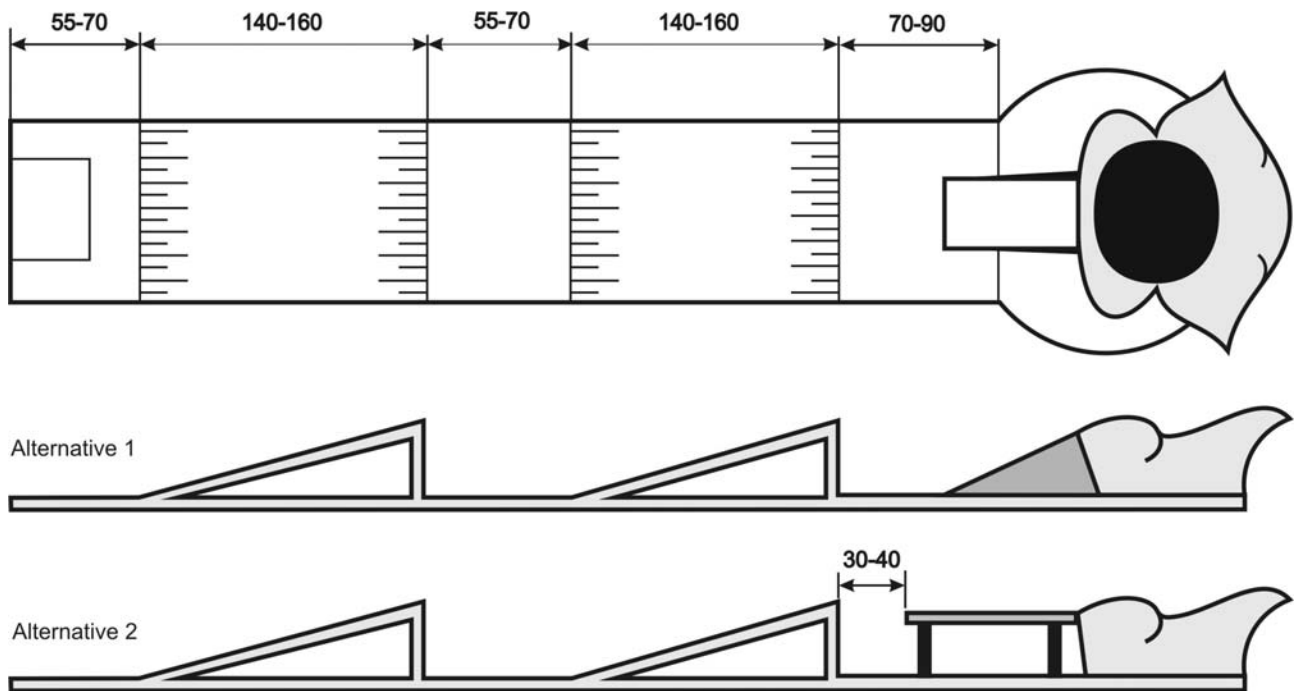

Intended path: Not laid down.

Measurements: Width of entrance to the bowl 12 – 25 cm (both alternatives)
Others see diagram

Border line: Lane without border line.

Target: Inside the bowl.

Lane-specific rule: It is allowed to loosen up up the sand/gravel.
It is allowed to step inside the lane for retrieving the ball.

Lane 14 passages

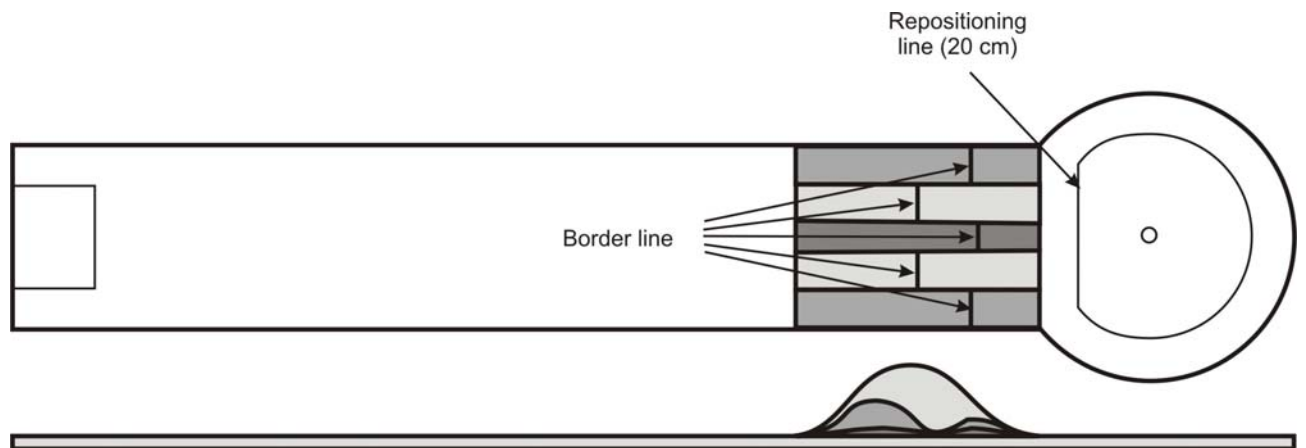

Intended path: Not laid down

Measurements: Rear edge of obstacle 500 cm from the beginning of the lane

Border line: Right after the top of the last hill in each passage

Lane 15 middle hill

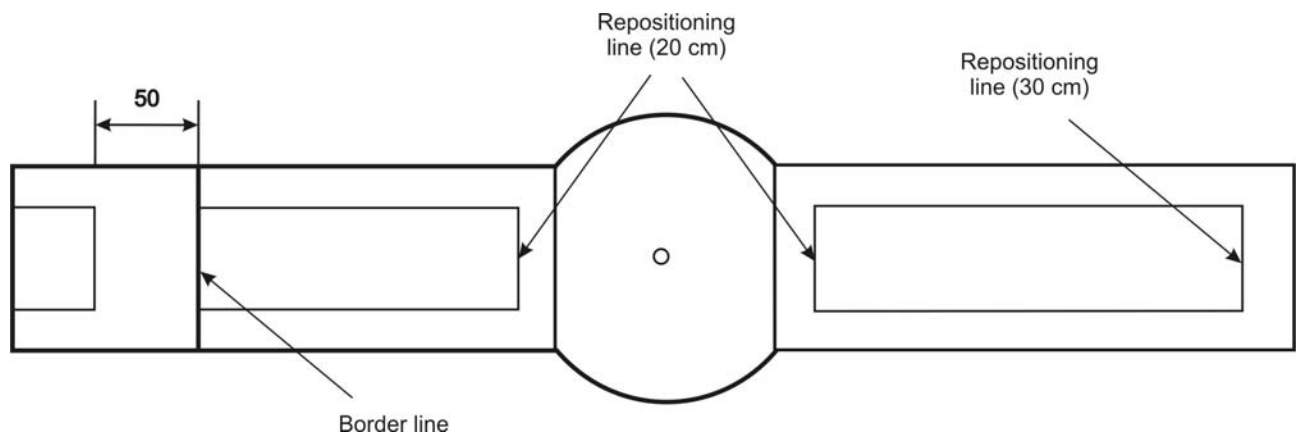

Intended path: Not laid down.

Repositioning: If the ball comes to rest on the hill it can be repositioned at up to 20 cm from the hill parallel to the boundary line in the direction from which it has come from. It can also be played from the point on the hill where it has come to rest.

Border line Border line is marked 50 cm ahead the teeing-off area.

Lane 16 volcano

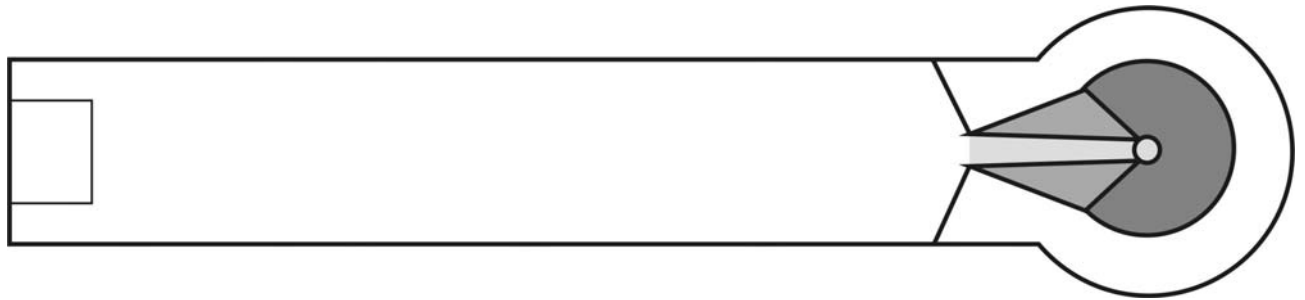

Intended path: Not laid down

Border line: Lane without border line

Target: The target hole and the complete plateau

Measurements: As a result of the position of the obstacle the target hole should be placed in the middle of the target circle.

Lane-specific rule: It is allowed to step inside the lane for retrieving the ball.

Lane 17 "V"-obstacle



Intended path: Not laid down, but ball is not allowed to jump over obstacles.

Measurements see drawing

- Alternatives:
- 1 Obstacles are linear sticks
 - 2 Obstacles are triangles (see drawing)
 - 3 Two sticks or triangles are close together at the bottom with target hole
 - 4 Two sticks or triangles are close together at the bottom without target hole (target can be a round mould)

Border line: Lane without border line.

Lane 18 angle

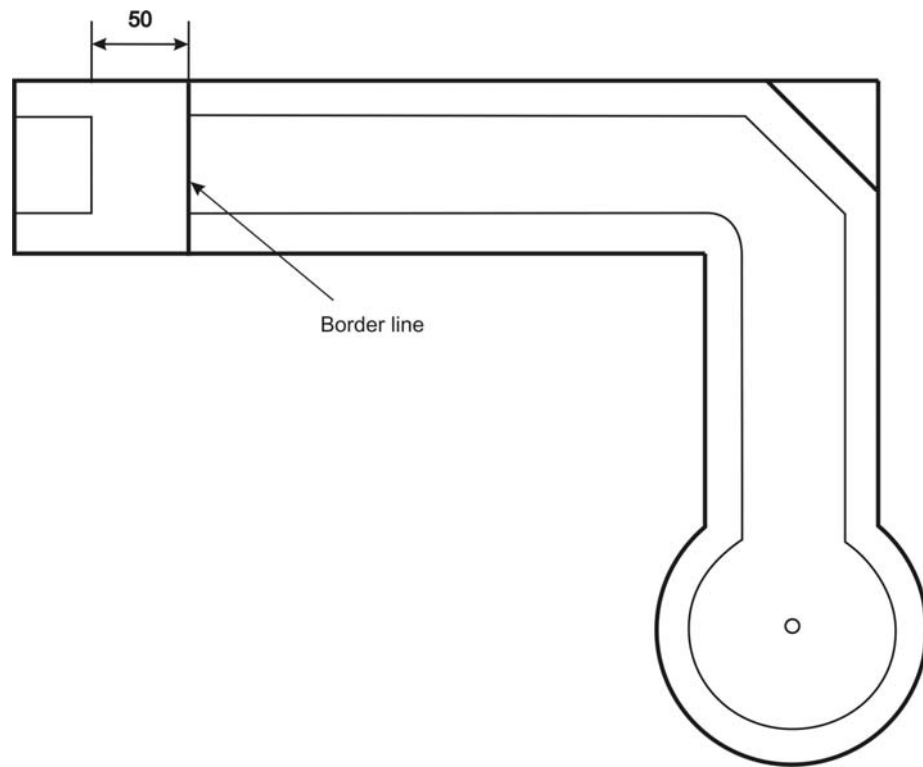

Intended path: Not laid down.

Border line Border line is marked 50 cm ahead the teeing-off area.

Measurements: Length of obstacle 40 – 60 cm

Lane 19 lightning

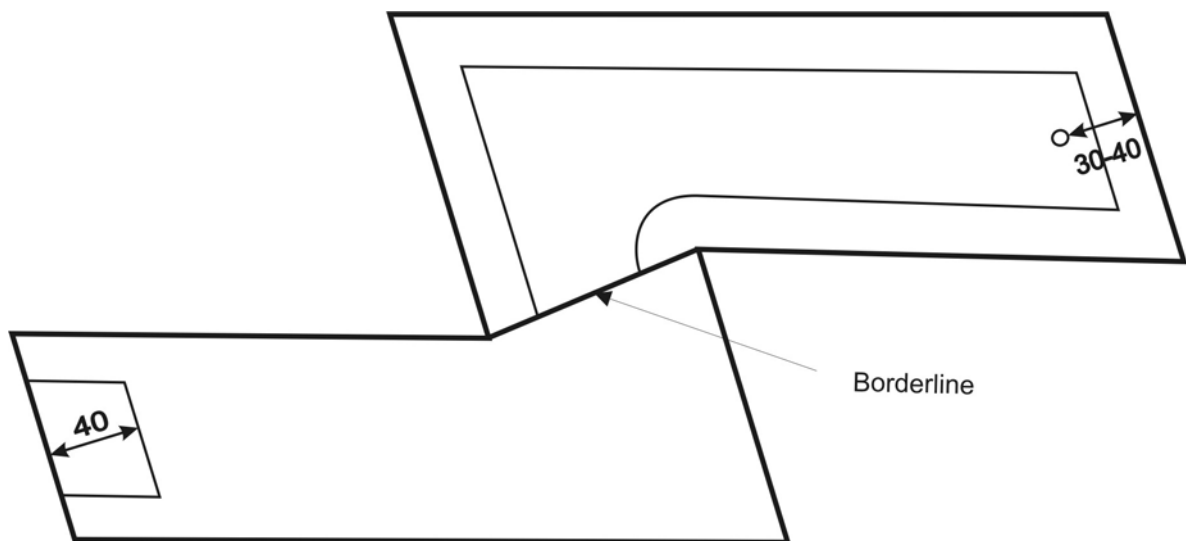

Intended path: Not laid down

Lane 20 straight lane without obstacles

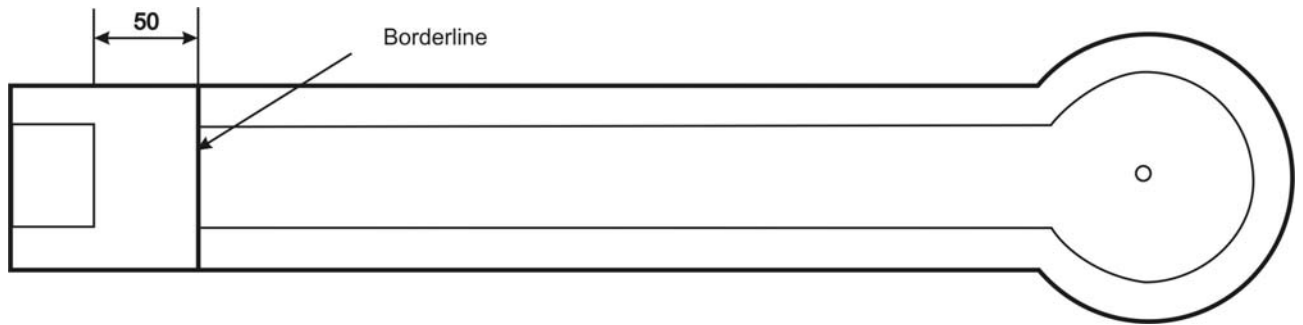

Intended path: Not laid down.

Border line Border line is marked 50 cm ahead the teeing-off area.

Lane 21 sloped circle without obstacles

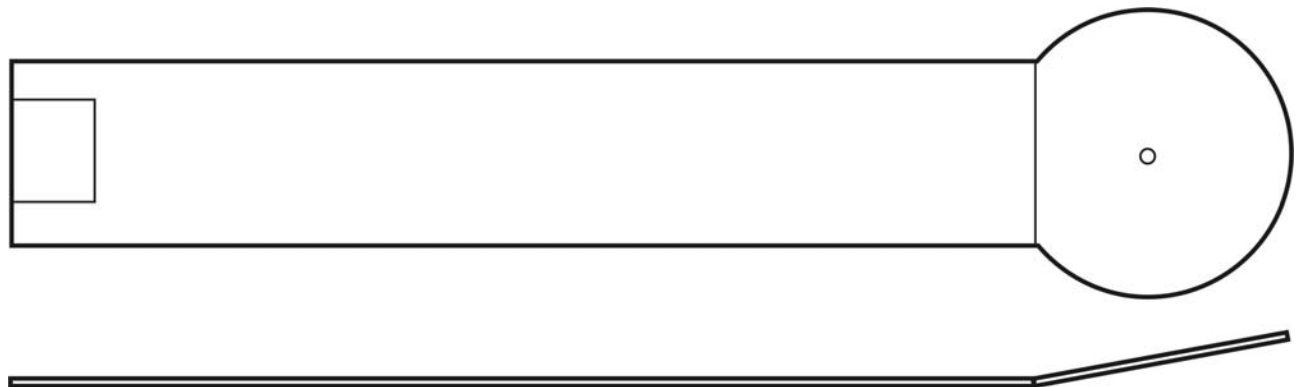

Intended path: Not laid down.

Border line: Lane without border line.

Lane 22 plateau

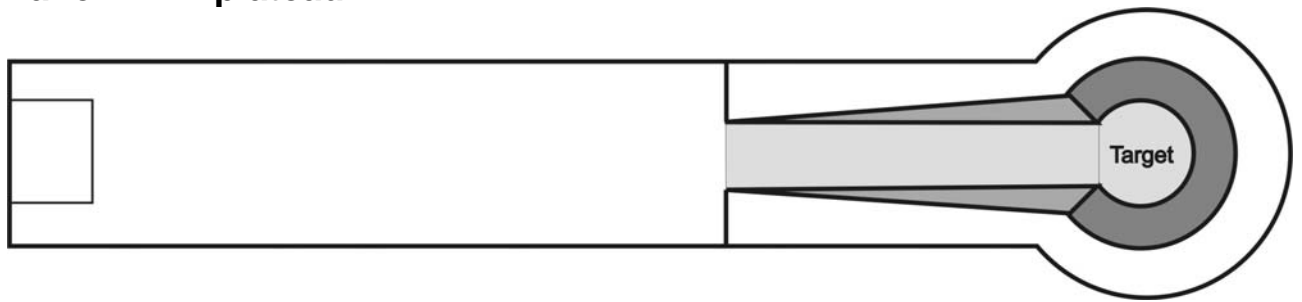

Intended path: Not laid down.

Measurements: beginning of obstacle 250–350 cm from beginning of the lane
 width of ramp entrance 12 – 25 cm
 Rear edge of plateau frame 0,8 – 1,7 cm
 Position of center of plateau 500–600 cm from beginning of the lane

Border line: Lane without border line

Target: Target area can be rectangular or round.

Others: Full course under the ramp is not requested.

Lane-specific rule: It is allowed to step inside the lane for retrieving the ball.

Lane 23 wedge with target window

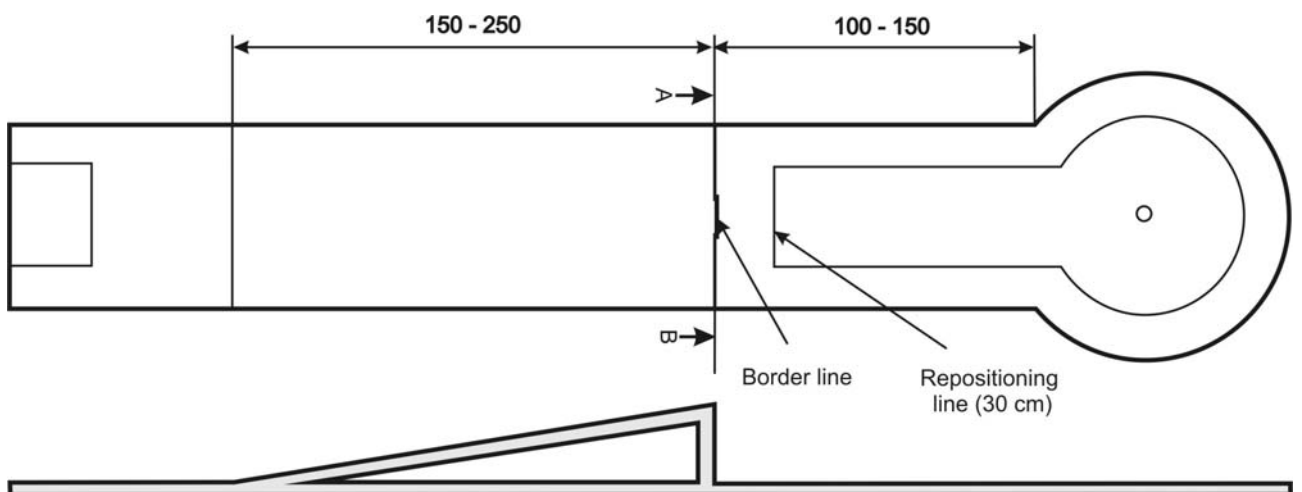

Sectional drawing A - B

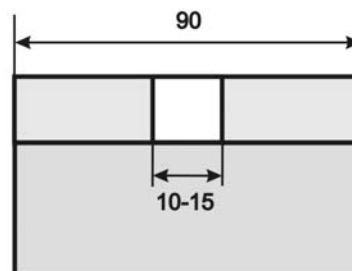

Intended path: Through the window

Measurements: Width of obstacle 10 – 15 cm
 Others see diagram

Lane 24 sloped lane without obstacles

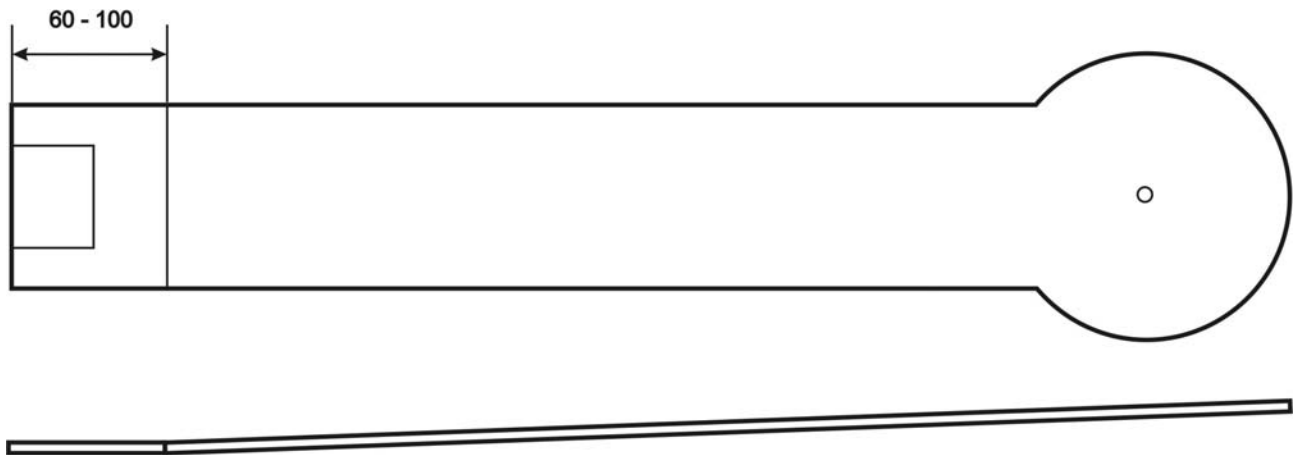

Intended path: Not laid down

Border line: Lane without border line

Lane 25 sloped circle with "V"-obstacle

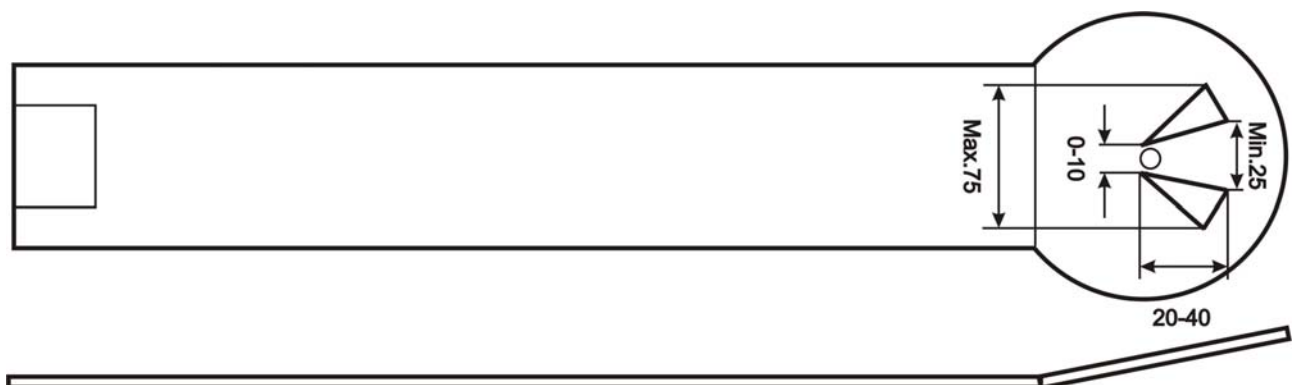

Intended path: Not laid down, but ball is not allowed to jump over obstacles.

Measurements see drawing

- Alternatives:
- 1 Obstacles are linear sticks
 - 2 Obstacles are triangles (see drawing)
 - 3 Two sticks or triangles are close together at the bottom with target hole
 - 4 Two sticks or triangles are close together at the bottom without target hole (target can be a round mould)

Border line: Lane without border line.

Lane 26 straight lane with jump

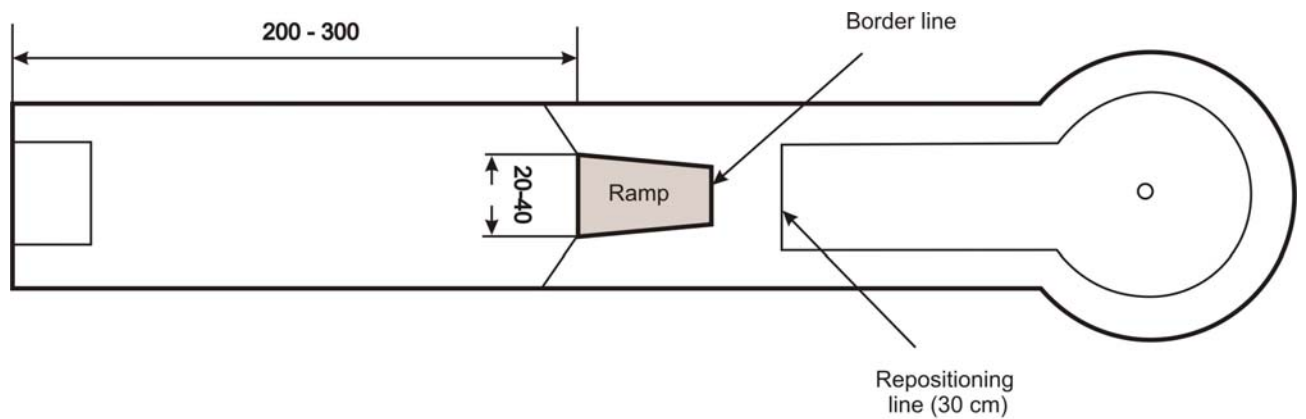

Intended path: Over the ramp

Measurements: See drawing

Border line: Border line is marked at the end of the ramp

Others: The ramp can be a regular or an irregular rectangle

Lane 27 rhombus

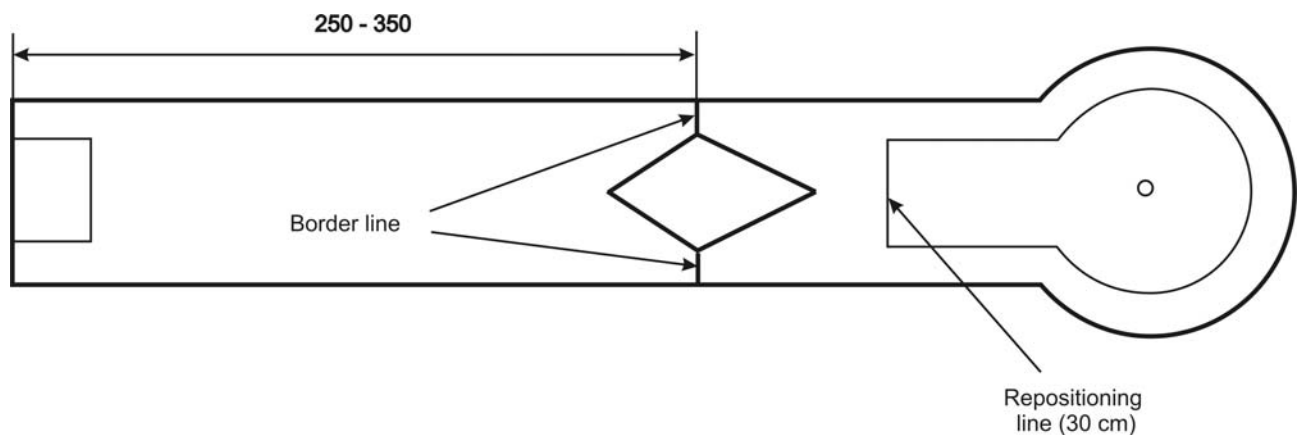

Intended path: Not laid down.

Measurements: Width of sideways 10 – 15 cm

Border line: Border line is marked each side just behind the point with smallest distance to the frame

Lane 28 straight lane with target hill

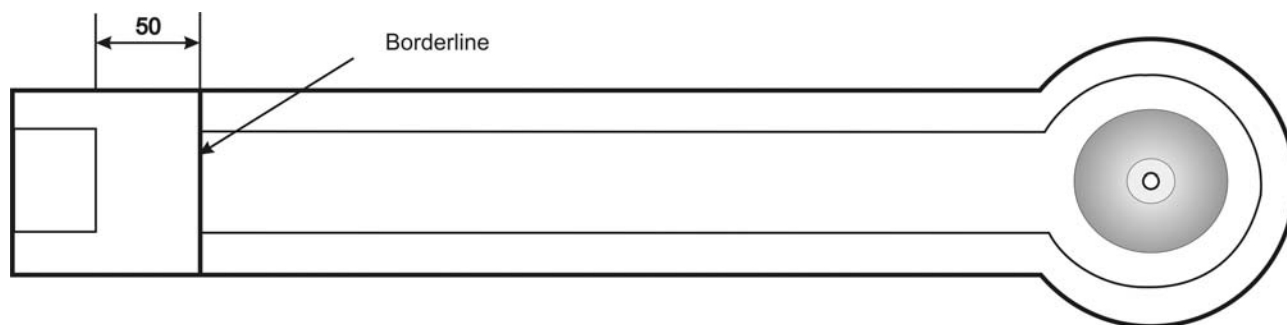

Intended path: Not laid down.

Measurements: Height of the target hill with same shape as lane 8 concrete
10 – 20 cm

Diameter of the hill 60 – 80 cm

Border line: Border line is marked 50 cm ahead the teeing-off area.